



Optigo OPI0 Manual

©Copyright AB Regin, Sweden, 2010

READY STEADY GO



THE CHALLENGER IN BUILDING AUTOMATION

DISCLAIMER

The information in this manual has been carefully checked and is believed to be correct. Regin however, makes no warranties as regards the contents of this manual and users are requested to report errors, discrepancies or ambiguities to Regin, so that corrections may be made in future editions. The information in this document is subject to change without prior notification.

The software described in this document is supplied under license by Regin and may be used or copied only in accordance with the terms of the license. No part of this document may be reproduced or transmitted in any form, in any fashion, electronically or mechanically, without the express, written permission of Regin.

COPYRIGHT

© AB Regin. All rights reserved.

TRADEMARKS

Optigo is a registered trademark of AB Regin.

Some product names mentioned in this document are used for identification purposes only and may be the registered trademarks of their respective companies.

August 2010

Document revision: 2010-08-27

Table of contents

Chapter 1 About the manual	5
More information	5
Chapter 2 Introduction to Optigo	6
Optigo controllers	6
Optigo OP10	7
Chapter 3 Technical data	8
Chapter 4 Installation and wiring	10
Installation	10
Wiring	11
Supply voltage	11
Inputs and outputs	12
Chapter 5 Control modes	14
Control modes 1, 2 and 3	14
Control mode 4, Radiator circuit control with outdoor curve	19
Control mode 5	21
Chapter 6 Display and encoder	22
The Basic level	22
The 3 second level	23
The 10-second level	23
Display symbols	24
Chapter 7 Setpoint	25
Chapter 8 Alarm handling	26
Chapter 9 Clock and scheduler	27
Real time clock	27
Scheduler, general	27
Scheduler, control modes 1, 2 and 3	27
Menus 0.1 – 0.8	27
Menu 0.9, Override	28
Menu OK	28
Scheduler, control mode 4	28
Menus 0.1 – 0.8	28
Menu 0.9, Setback	29
Menu OK	29
Chapter 10 Configuration	30
Menus 1.0 – 5.0	30
Menus X.1 Output type (control modes 1, 2, 3 and 4) (where X depends on your choice of alternative above)	30
Menu X.A	30
Menus X.2 Output signals (control modes 1, 2, 3)	31

Menu X.3 Neutral zone (Control modes 1, 2 and 3)	31
Menu X.4 P-band	32
Menu X.5 I-time	32
Menu X.6 Damper minimum position (Control modes 1, 2 and 3) P-band room temperature influence (control mode 3) 0°C temperature boost (Control mode 4) D-factor (control mode 5)	32
Menu X.7 Universal input UI1 (Control modes 1, 2, 3) Pump exercise (Control mode 4) Periodic overheating (Control mode 5)	33
Menu X.8 Startpoint for outdoor compensation, S.P (Control mode 2) Supply air min limit (Control mode 3) Low temperature setpoint (Control mode 4)	34
Menu X.9 Maximum compensation, CMP (Control mode 2) Supply air max limit (Control mode 3) High temperature setpoint (Control mode 4)	35
Menu X.E	35
Menu I/O	36
Menu OK	36
Storage of settings	36
Reset to factory setting	36

Chapter 11 **Index** **37**

Chapter 1 About the manual

This manual describes the controller Optigo OP10 and OP10-230. It is applicable to program revisions from R20.



Make sure that you always follow the safety regulations in the documentation to prevent risk of fire, electric shock and personal injury.

More information

More information on OP10 can be found in:

- *Optigo controllers* – Sales brochure for Optigo controllers
- *Optigo product instruction*

The information is available for download from Regin's homepage, www.regin.se.

Chapter 2 Introduction to Optigo

Optigo controllers

Optigo is a range of pre-programmed, configurable controllers that can be set to handle everything from temperature control or humidity control to CO₂ control or pressure control.

OP5 and OP10

The Optigo series comprises two different types, OP5 and OP10.

OP5 has 5 inputs/outputs and can be configured to control Temperature, CO₂, Humidity or Pressure. From revision 18, there is a new analogue input for connection of an external PT1000 setpoint device for control mode 1 (Temperature control).

OP10 has 10 inputs/outputs and can be configured to control Temperature (ventilation control with heating and cooling), Water-heated radiator heating with outdoor temperature dependent control-curve or Domestic hot-water control. From revision 20, there is a new analogue input for connection of an external PT1000 setpoint device for control modes 1-4. OP10 is available in two versions, OP10 with 24 V AC supply voltage and OP10-230 with 230 V AC supply voltage.

Mounting

Optigo is designed primarily for DIN-rail mounting but can also be screw-mounted to any suitable surface.



Optigo OP10

Optigo OP10 is a pre-programmed, configurable controller. It has been designed with the main intention of replacing a number of Regin's Aqualine controllers.

All configuration and normal handling is done using the display and the knob on the front.

In- and Outputs

Optigo OP10 has

- 2 analogue inputs, PT1000
- 1 analogue input for an external setpoint device, PT1000 (from R20)
- 1 universal input, PT1000 or digital
- 2 digital inputs
- 3 digital outputs
- 2 analogue outputs, 0...10 V DC

Control modes

Optigo OP10 is pre-programmed with a choice of 5 different control modes:

- Supply air control
- Outdoor temperature compensated supply air control
- Cascade connected room / extract air temperature control
- Radiator circuit control
- Domestic hot water control

Internal clock

Optigo OP10 has a built-in week-base real time clock with a number of different scheduler alternatives.

Chapter 3 Technical data

Supply voltage	OP10-230: 230 V AC; +10 / -15%; OP10: 24 V AC; ±15%. 50/60 Hz
Power consumption	6 VA
Running mode	
Climatic conditions according to IEC 721-3-3	Class 3k5
Ambient temperature	0...50°C
Ambient humidity	Max 95% RH
Mechanical requirements according to IEC721-3-3	Class 3M3
Vibration.....	IEC60068-2-6, Test FC, vibration Sinusoidal
Shock	IEC60068-2-27, Test Ea
Transport	
Climatic conditions according to IEC 721-3-2	Class 2k3
Ambient temperature	-20...+70°C
Ambient humidity	Max 95% RH
Mechanical requirements according to IEC721-3-2	Class 2M2
Vibration.....	IEC60068-2-6, Test FC, vibration Sinusoidal
Shock	IEC60068-2-27, Test Ea
Free fall.....	IEC60068-2-27, Test Ed
Storage	
Climatic conditions according to IEC 721-3-1	Class 1k3
Ambient temperature	-20...+70°C
Ambient humidity	Max 95% RH
Terminals.....	Disconnectable, lift type for cable cross-section 2.5 mm ²
Protection class.....	IP00
Material casing	Polycarbonate, PC
Colour	
Cover	Silver
Bottom part.....	Dark gray
Weight	OP10-230: 370g; OP10:215 g incl. terminals
Dimensions.....	122 (7 modules) x 120 x 64 mm (WxHxD incl. terminals)

LVD, Low Voltage Directive

This product conforms with the requirements of European LVD standard EN61010-1.

EMC emissions an immunity standard

This product conforms with the requirements of European EMC standards CENELEC EN 61000-6-1 and EN 61000-6-3 and carries the CE mark

Inputs

AI.....	Resolution: 10 bit A/D
AI1	PT1000-sensor, range 5...80°C
AI2	PT1000-sensor, range -30...+50°C
SPI	PT1000 setpoint device, range 0...40°C
UI	
AI.....	PT1000, range 0...80°C
or DI	Closing potential-free contact
A _{GND}	Reference for AI
UI+	Reference for UI
DI.....	Closing potential-free contact
DI+	Reference for DI

Outputs

AO..... 0...10 V DC; 8 bit D/A short-circuit protected
 DO1 and DO2 (OP10)..... Triac controlled, 24 V AC, 0.5 A continuous (connected to G0)
 DO1 and DO2 (OP10-230).. Triac controlled, 24 V AC, 0.16 A continuous with internal trafo
 (connected to G0)
 DO3 Change-over (SPDT) relay 230 V AC, 1000 VA
 G_{DO}..... Reference for DO1 and DO2. 24 V AC output

Other data

Display Numeric / graphic. Background illumination.

Setpoints

	Range	Factory setting
Temperature		
supply air	10...80°C	21°C
room	10...50°C	21°C
tap hot water	10...80°C	55°C
External setpoint	0...40°C	
P-band	0...99°C	15°C
I-time	0...990 s	60 s
D-factor	0...99	0
Cascade factor	0...99	2
Minimum at cascade	0...99°C	15
Maximum at cascade	0...99°C	25
Damper minimum limit	0...99	10
Start of outdoor compensation	-30...50°C	10°C
Outdoor compensation at -20°C outdoor temp	-10...10°C	5°C
Supply temperature (water-heated radiator heating)		
at -20°C outdoor temperature	0...99°C	60°C
at 20°C outdoor temperature	0...99°C	20°C
Frost protection	7°C (fixed)	
Shutdown mode	25°C (fixed)	

Accessories

Temperature sensors.....PT1000 sensors, for example: TG-R5/PT1000, TG-KH/PT1000
 Setpoint device PT1000, e.g. TG-R4/PT1000 or TBI-PT1000
 Casing.....EK216

The accessories are available from Regin. For more detailed information, see product sheets and instructions which are available at www.regin.se.

Chapter 4 Installation and wiring

Installation

Optigo is intended to be installed and handled by professional personnel.

The installation should conform to the requirements of installation category 3 and pollution degree 2.

There are a number of mounting alternatives:

- DIN-standard casing (minimum 7 modules)
- Cabinet, either on a DIN-rail or, using the two screw-pockets provided, by being screwed to any suitable flat surface in the cabinet
- The controller can also be mounted in a cabinet door or other control panel, using a suitable front-mounting kit



For installations which are connected to 230 V AC:

- Observe that there is a risk of electric shock on contact with terminals 1-3 and 10-12.
- Mount Optigo in a DIN-casing or similar where it can be used without risk of electric shock. The casing should provide at least 6 mm insulation from connected cables and terminals 1-3 and 10-12.
- Optigo should be protected against overload by a fuse in the installation. Since the maximum load is 1000 VA, a fuse of 6 A is suitable.
- Circuit breaker and fuse: The controller should be connected to a circuit breaker so the power supply to the controller can be cut. Place this breaker close to the controller where it is easy for the operator to reach. It should be clearly marked as a circuit breaker for the controller.

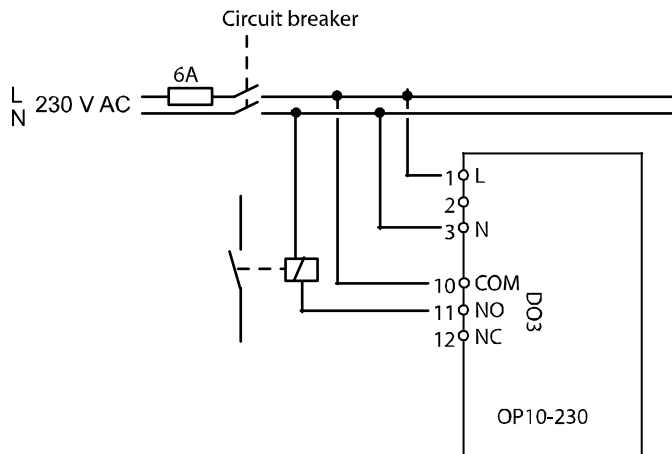

Wiring

This section only describes general rules and technical limitations concerning the wiring. In chapter 5 there are specific wiring diagrams for the different control modes. Choose the one suitable for the application on hand.

It is important to make sure that the wiring is correctly done, in accordance with the instructions given in this manual and in accordance with local legislation for this type of installation.

1	G	24 V AC Optigo 10 only	1	L	230 V AC Optigo 10-230 only
2	G0		2		
3	⎓		3	N	

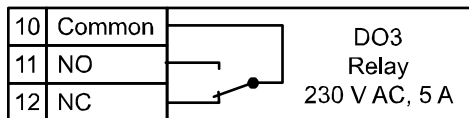

13	G _{DO} Reference for DO1 and DO2
14	DO1 Digital output
15	DO2 Digital output
20	A _{GND} Reference for AO1 and AO2
21	AO1 0...10 V DC output
22	AO2 0...10 V DC output

40	DI2 Digital input
41	DI+ Reference for DI1 and DI2
42	DI1 Digital input
43	UI+ Reference for UI1
44	UI1 Universal input PT1000 or Digital
50	A _{GND} Ref for AI1
51	AI1 PT1000 temp sensor input
52	A _{GND} Ref for AI2
53	AI2 PT1000 temp sensor input
54	SPI Input PT1000 setpoint device

Supply voltage

OP10-230: 230 V AC +10%, -15%, 50/60 Hz. 6 VA

OP10: 24 V AC ±15%, 50/60 Hz. 6 VA

If the Optigo OP10 (24V supply model only) and actuators connected to it share transformer, it is essential that the same transformer-pole is used as reference for all the equipment. Failure to do so will prevent the equipment from functioning as intended and may also lead to damages.

Inputs and outputs

A_{GND}

All A_{GND} terminals are interconnected and also connected to G0.

Analogue inputs AI

The analogue inputs must refer to an A_{GND} terminal. AI1 and AI2 are for PT1000 temperature sensors only. AI1 has a temperature range of 0...84°C. AI2 has a temperature range of -30...+54°C. SPI is only intended for a PT1000 setpoint device, the range is 0...40°C.

Digital inputs DI

The digital inputs must refer to DI+ on terminal 41. The digital inputs may only be wired to voltage-free contacts. Any external voltage applied to a digital input may harm the unit.

Universal input UI

The universal input can, depending on the choice of application, be made to act as either an analogue input or as a digital input.

When used as an analogue input it is for PT1000 temperature sensors. The input then has a range of 0...+84°C

UI must refer to UI+ on terminal 43.

Analogue outputs

Analogue outputs must refer to a A_{GND} terminal or directly to G0.

If the Optigo OP10 (24V supply model only) and actuators connected to it share transformer, it is essential that the same transformer-pole is used as reference for all the equipment. Failure to do so will prevent the equipment from functioning as intended and may also lead to damages.

Digital outputs

The two digital outputs DO1 (terminal 14) and DO2 (terminal 15) are triac controlled. The triacs are internally connected to G0. Each triac can handle 24 V AC, 500 mA. The outputs cannot be used to drive DC relays.

When DO1 and DO2 are used for 3-point control DO1 will always be increase signal (open valve) and DO2 always decrease signal (close valve)

The outputs should normally refer to G_{DO} on terminal 13. G_{DO} is internally connected to G and supplies 24 V AC.

In OP10 G_{DO} can deliver the necessary 2 x 500 mA.

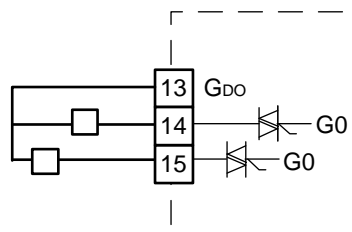

In OP10-230 however, the internal transformer's capacity restricts the current on G_{DO} to approx. 165 mA.

For more power an external transformer must be used. Wire the transformer according to the following figure. The two 500 mA fuses are important to prevent possible overloading of the triacs.

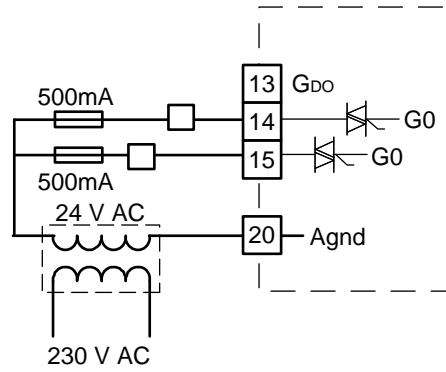

Chapter 5 Control modes

Optigo can be configured to any one of the following control modes.

1. Supply air temperature control.

The supply air temperature is kept at the setpoint value by controlling the output signals on AO1 and AO2. A single PI control loop is used.

2. Supply air temperature control with outdoor compensation.

The supply air temperature is kept at the setpoint value by controlling the output signals on AO1 and AO2. A single PI control loop is used.

The setpoint is automatically adjusted according to the outdoor temperature.

3. Cascade connected, room temperature influenced, supply air control.

The room temperature is controlled by means of adjustments in the supply air temperature, depending on the room temperature. A cascade controller with a room temperature and supply air temperature sensor is used. The supply air temperature is minimum and maximum limited.

4. Radiator circuit control with outdoor curve.

The water temperature setpoint is changed according to the outdoor temperature. A single PI control loop is used. A room temperature sensor can be added to give corrective action if the room temperature differs from the setpoint

5. Domestic hot water control.

The water temperature is kept constant by controlling the output signal on AO1. A single PID control loop is used.

Control modes 1, 2 and 3

These three modes have a lot in common and will therefore be treated in a single section.

For control mode 1, "Supply air temperature control" you need only one sensor, "Supply air sensor" on AI1.

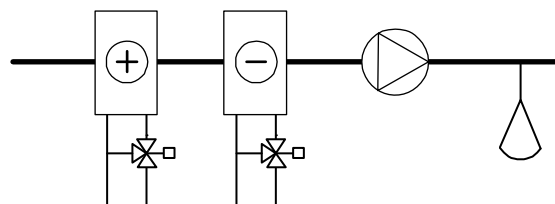

For control mode 2, "Supply air temperature control with outdoor compensation" you need two sensors, "Supply air sensor" on AI1 and "Outdoor sensor" on AI2.

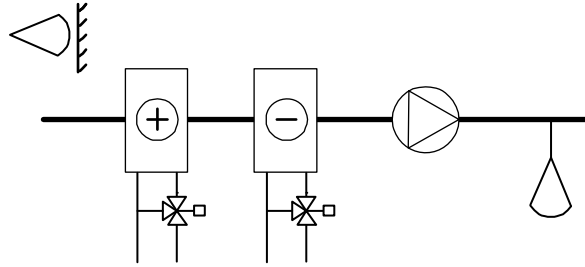

For control mode 3, “Cascade connected room / extract air temperature control” you also need 2 sensors, “Supply air sensor” on AI1 and “Room sensor”, which are placed in the room or in the extract air on AI2.

The cascade controller has inputs for supply air sensors and room sensors. The room temperature setpoint is set and the controller will adjust the supply air setpoint until reaching the desired room temperature. The supply air setpoint is minimum and maximum limited. The P-band and I-time values for the supply air control are chosen so that a stable control is achieved. The P-band for the room temperature influence is set on PCd. The I-time for the room temperature influence is a fixed value of 600 seconds.

Definition of P-band the room temperature influence (PCd): The change in room temperature which results in a change in the supply air setpoint, corresponding to the difference in temperature between the set maximum and the minimum limits.

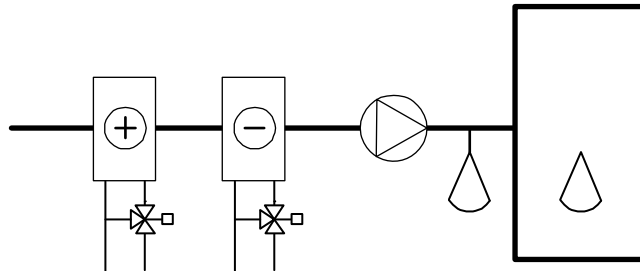

The analogue outputs can be configured to the following combinations:

AO1 / AO2

1. Heating / -
2. Cooling / -
3. Heating / Cooling
4. Heating / Heating
5. Cooling / Cooling
6. Heating / Dampers
7. Cooling / Dampers

In alternative 4, Heating-Heating AO2 will be activated first on increasing heat demand.

In alternative 5, Cooling-Cooling AO2 will be activated first on increasing cooling demand.

In alternative 6, Heating-Damper, at temperatures above the setpoint the damper on AO2 will be fully open. On increasing heating demand, the damper on AO2 will first close to the set minimum value before the heating output on AO1 starts to increase.

In alternative 7, Cooling-Damper, at temperatures below the setpoint the damper on AO2 will be fully open. On increasing cooling demand, the damper on AO2 will first close to the set minimum value before the cooling output on AO1 starts to increase.

3-position control

Instead of an analogue output you can configure a single 3-position (increase / decrease) output. You will then only have the following output choices:

Heating

Cooling

DO1 is used for increase signal and DO2 for decrease. This option cannot be combined with alarm output.

A single P control loop is used.

OP10-230 generates 24 V AC itself for control of 3-position actuators. 230 V actuators cannot be used without relays.

External setpoint

From revision 20, it is possible to use an external PT1000 setpoint device, e.g. TG-R4/PT1000 or TBI-PT1000. The setpoint device is connected between terminal 54 SPI and the reference for the analogue inputs, AGND. For more information on configuration and setpoint reading, see chapters 7 and 10.

Universal input UI1

Electric heating

If the Optigo is used to control electric heating UI1 is used for the high temperature limit switch. Connect and configure as a digital input. The input is normally closed. Whenever the running mode switches to “Off”, (normal shutdown) the heating output will be shut down immediately but the fan will run on for a further 3 minutes to cool the heater. On activation of the high temperature limit, the heating output will be shut down immediately and there will be no cool-down period.

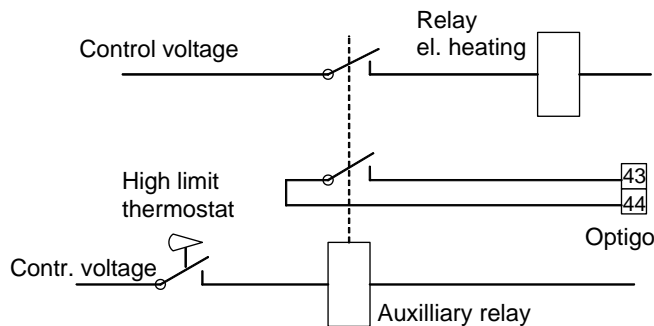

Wiring suggestion for high temp limit when using electric heating. Drawn with high temp limit activated.

N.B. It is important that the high temperature thermostat is hardwired to disconnect the power to the heater to ensure that the heating is shut down when the thermostat is activated even if the Optigo should be faulty.

Water heating

When controlling a water heater, UI1 can, when necessary, be used for a frost protection sensor. Connect and configure as an analogue input. The frost protection function can be tied to either of the analogue outputs.

The heater return water temperature is monitored by the frost protection sensor. Should the temperature at the frost protection sensor fall below 12°C an internal, proportional signal is generated that is used to force the heating valve open to try and prevent freeze-up of the heater.

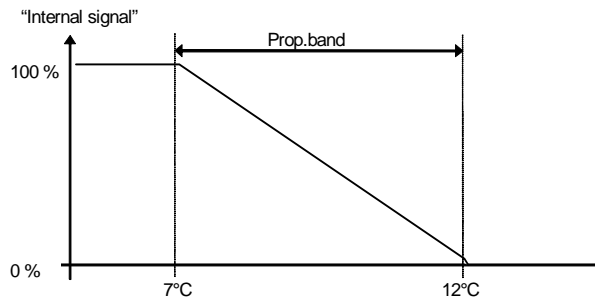

The frost protection signal (“Internal signal”) will increase linearly to 100 % at 7°C at which point the frost protection alarm is triggered. The fan will then be shut down and the controller will go into shutdown mode.

Shutdown mode (Only if frost protection sensor has been configured)

Whenever the running mode switches to ”Off”, (normal shut-down or frost protection is activated) the controller will go into ”Shutdown mode”. The shutdown controller will control the output that is tied to the frost protection function to maintain a constant 25°C at the frost protection sensor.

Outdoor compensation

In control mode 2, Supply air control with outdoor temperature compensation, the supply air temperature setpoint can be displaced according to outdoor temperature. The displacement starts from outdoor temperature S.P and reaches the setpoint value + the compensation (CMP) at -20°C outdoor temperature. For example: Normal setpoint = 20, S.P=10 and CMP = 5 will give the following result:

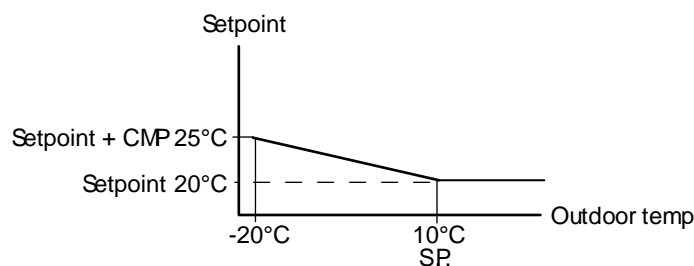

Damper

It is possible to set a minimum limit value to the damper output signal. The damper-output will then not go lower than the set value during normal operation. On shut-down however the signal will go to zero.

In the output mode heating – damper the damper will be fully open for temperatures higher than the setpoint. On increasing heat demand the damper will first close to the minimum value before the heating output starts to increase.

In the output mode cooling – damper the damper will be fully open for temperatures lower than the setpoint. On increasing cooling demand the damper will first close to the minimum value before the cooling output starts to increase.

DI1, Fan indication

Unless the fan indication input is active (closed) indicating that the fan is running, the controller will not start normal temperature control and an alarm will be generated. An alarm will also be generated if the input is active (closed) when the fan control output is off.

DI2, Extended running

Activation of this input will force the controller to running mode even if internal scheduler is in Off-mode. The unit will run as long as the input is activated.

Wiring examples



See also chapter 4 *Installation and wiring*.

A. OP10 with electric heating (for example via PULSER-X/D or TTC25X) and damper. Cascade control.

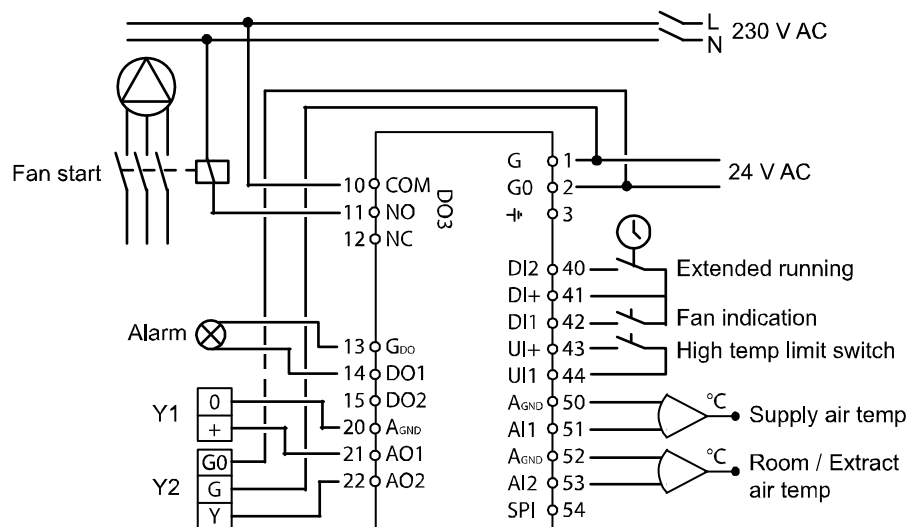

B. OP10-230 with water heating, 3-position output. Supply air temperature control with outdoor compensation and external setpoint device.

OP10-230 generates 24V AC itself for control of 3-position actuators. 230 V actuators cannot be used without relays.

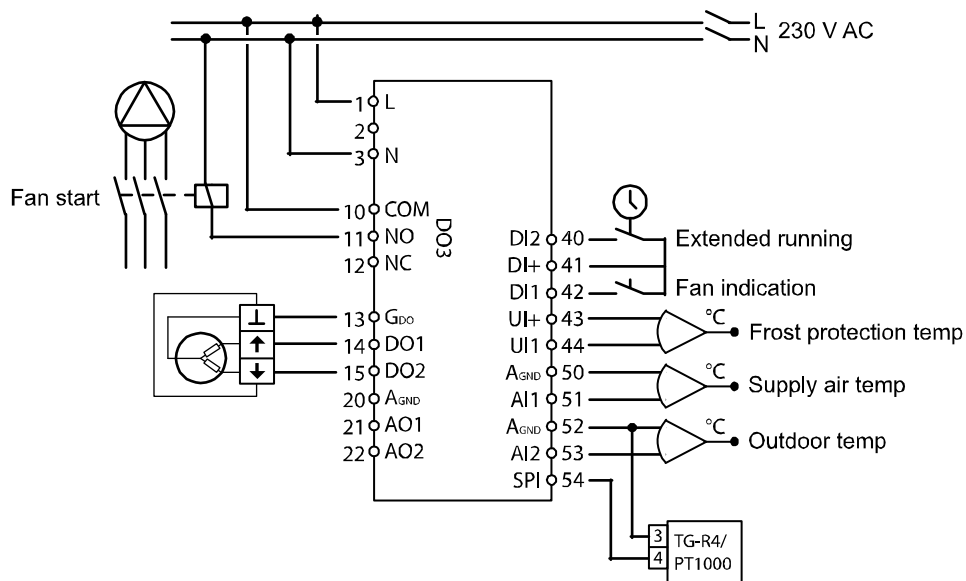

Control mode 4, Radiator circuit control with outdoor curve

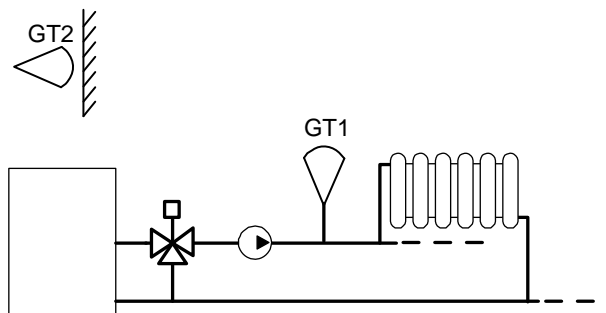

For this control mode you need two sensors, GT1 “Supply temperature” on AI1 and GT2 “Outdoor sensor” on AI2.

You can also have a room temperature sensor on UI1 to let the room temperature offset give correction to the supply temperature. Wire UI1 as an analogue input. When using a room sensor, it is possible to set the room setpoint via an external PT1000 setpoint device (this applies to controllers with revision R20 or later).

3-position control

Instead of the analogue output you can configure a 3-position (increase / decrease) output using DO1 and DO2. DO1 is used for increase signal and DO2 for decrease. This option cannot be combined with alarm output.

A single P control loop is used.

OP10-230 generates 24V AC itself for control of 3-position actuators. 230 V actuators cannot be used without relays.

Control curve

The supply temperature setpoint is determined by a outdoor temperature/supply temperature curve. The basic control curve is a straight line between the two setpoints SP_L and SP_H where SP_L is the supply temperature to be held when the outdoor temperature is $+20^\circ\text{C}$ and SP_H is the temperature to be held at an outdoor temperature of -20°C . An extra temperature boost can be added at 0°C outdoor temperature. The boost recedes from the set value to 0 over ± 3 degrees. In the Setpoint menu a parallel displacement of the whole curve can be added.

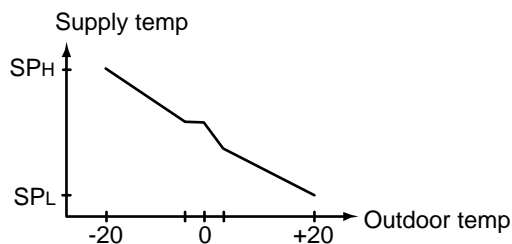

Room temperature sensor(s)

An optional room sensor can be connected to UI1. If a room sensor is used, it must be connected to the Optigo before control mode 4 is selected. Otherwise, the controller will not detect the sensor. To activate/deactivate the room sensor it has to be connected/not connected to the Optigo before control mode 4 is selected. The control program is automatically adapted when a room sensor is connected. Deviation of the set room temperature is corrected by increasing/decreasing the supply temperature by 3°C per one degree of deviation.

Control mode 5

Domestic hot water control

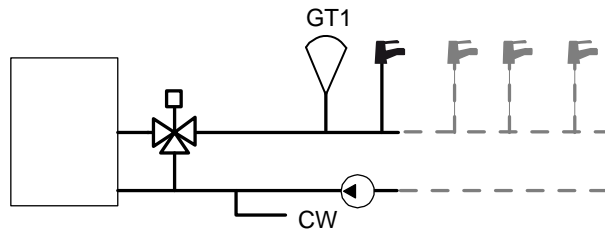

For this control mode you need a single sensor, “Supply water temperature” on AI1

Periodic overheating

To reduce the risk of Legionella bacteria growth a periodic overheating of the water can be configured. The water temperature will be raised to 65°C once daily at 03:00 (3 am). The elevated temperature is maintained for 10 minutes. The function can be deactivated.

Wiring example

OP10 with 0...10V actuator

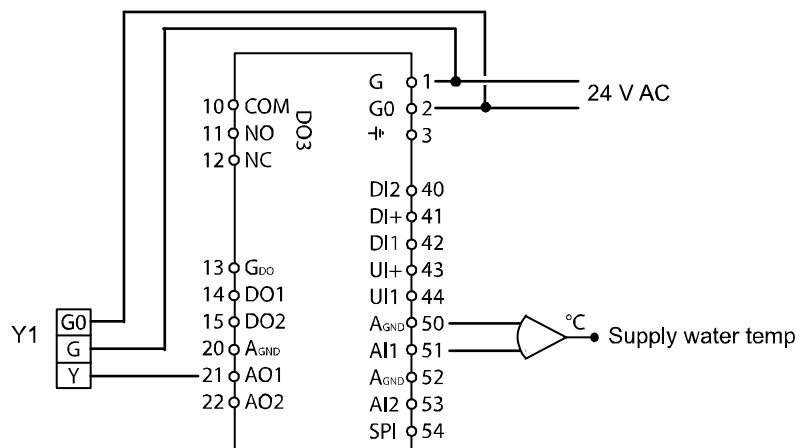

Chapter 6 Display and encoder

All setting and configuration is done using the display and encoder.

The menu information on the display is organised in a tree fashion. Using the encoder you can move between menus, set values etc.

In any of the configuration menus, a click on the encoder will activate change mode. You can then rotate the encoder button to move between choices or set values. A second click of the button will accept the choice.

The menu system is divided into three levels: The Basic level, the 3-second level which contains the clock and scheduler settings and the 10-second level which contains all the configuration menus.

The Basic level

The Basic level comprises four sets of menu displays, the Base Display, the I/O Displays, the alarm handling display and the Setpoint Display.

Base Display



This is an example of the Base Display, the display that is normally shown when there is no operator activity.

It shows the current time and the actual value of the main parameter. There are bar-graphs showing the current output levels together with symbols showing how the outputs have been configured (Heating, Cooling or damper etc). Also a symbol showing which of the five control modes is configured and an alarm symbol that is displayed in the event of an alarm condition. The fan symbol (control modes 1, 2 and 3 only) is lit as long as the fan indication input is activated.

I/O

When the Base Display is shown, by twisting the knob counter clockwise until the text I/O is displayed and then clicking on it, you can gain access to a menu where you can look at the values and states of all inputs and outputs.

To exit this menu again, click on the knob and then twist the knob clockwise and you will be returned to the Base display.

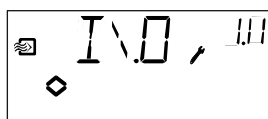

Setpoint

When in the Base Display, a click on the encoder button gives direct access to the Setpoint menu. See chapter 7 Setpoint.

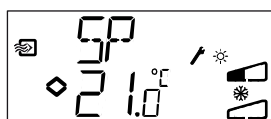

If there are any active alarms, clicking on the encoder button will instead give access to the alarm handling menus. Here the alarms are displayed and can be acknowledged. There is one menu display for each alarm with symbols showing which type of alarm it is. See chapter 8 Alarm handling.

Calculated setpoint

For control modes with outdoor temperature compensation or cascade control, the controller does not work towards a fixed setpoint value. Instead, it works towards a calculated setpoint, which varies with the outdoor temperature or, when using cascade control, the room temperature. The calculated setpoint is displayed by turning the knob clockwise when in the Base Display.



Control mode 2
Supply air temp control
with outdoor compensation



Control mode 3
Cascade connected
room control



Control mode 4
Radiator circuit control
with outdoor curve

The 3 second level

This level is reached from the Base display by clicking and holding the encoder button for 3 seconds. The 3-second level holds all menus for setting the clock and the scheduler program. See chapter 9 Clock and Scheduler.

The 10-second level

This level is reached from the Base display by clicking and holding the encoder button for 10 seconds.

The 10-second level holds all the configuration menus. See chapter 10 Configuration.

Display symbols

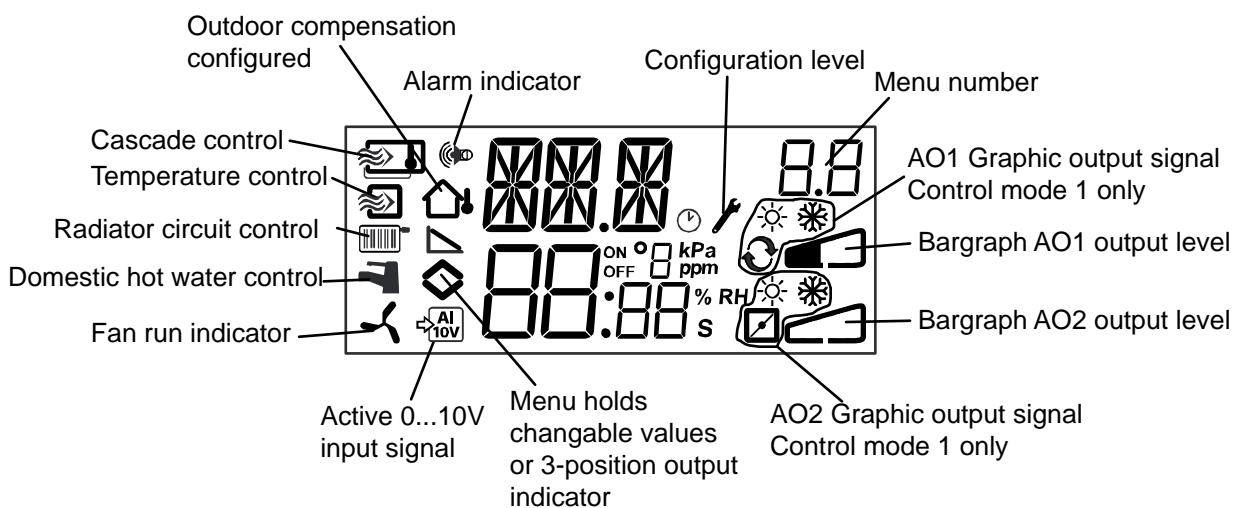

Chapter 7 Setpoint

The setpoint menu is normally accessed from the base display by a clicking on the encoder knob.

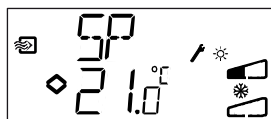

If you wish to change the displayed value, click on the knob again and the change indicators will start to flash to show that you are now in change mode. Turn the knob, clockwise to increase the value, anti-clockwise to decrease.

When the desired value is shown, click on the knob to acknowledge. To return to the base display, turn the knob.

For configurations involving a single output signal the setpoint is the starting point for the output signal.

For configurations involving two diverging output signals with neutral zone (heating – cooling) the setpoint is placed in the middle of the neutral zone.

For configurations involving two outputs without neutral zone (heating – heating, cooling – cooling, heating – damper or cooling – damper) the setpoint value is the starting point for the first sequence (AO2).

External setpoint (SPI)

When using an external setpoint device, the setpoint can be read by clicking on the knob while in the base display. If you click on the knob again, a symbol will start to blink, indicating that an external setpoint device is being used and that the setpoint cannot be changed via the display. External setpoint can be used for control modes 1-4. The SPI input can also be read via the I/O menu.

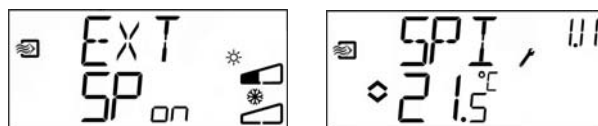

Control mode 4, Radiator circuit control

If no room sensor is configured the setpoint menu is used to add a parallel displacement to the outdoor curve. The displacement can be either positive or negative. The setpoint is shown as ΔSP .

If room sensor is activated the Setpoint menu is used to set the room temperature instead of adding a parallel displacement.

An optional room sensor can be connected to UI1. If a room sensor is used, it must be connected to the Optigo before control mode 4 is selected. Otherwise, the controller will not detect the sensor. To activate/deactivate the room sensor it has to be connected/not connected to the Optigo before control mode 4 is selected. The control program is automatically adapted when a room sensor is connected. Deviation of the set room temperature is corrected by increasing/decreasing the supply temperature by 3°C per one degree of deviation. The setpoint is shown as SP.

To indicate that room control is activated the display symbol showing a thermometer outside the house is replaced by a thermometer inside the house.

Chapter 8 Alarm handling

If there are any active, unacknowledged alarms, the alarm indicator in the Base Display will light up and start flashing. If DO1 is configured as alarm output, it will be activated. The alarm handling menus are accessed from the Base Display by a click on the encoder knob. The first alarm is displayed.

There are four different alarm types:

- AL1 Frost protection alarm. The frost protection temperature has fallen below +7°C
- AL2 High temperature limit switch activated.
- AL3 Fan indication alarm. Either there is no fan indication input on DI1 when the fan start output, DO3 is active or DI1 is active although there is no fan start signal on DO3. The fan alarm has a 30 second delay.
- AL4 Sensor error. A sensor input is open circuit.

A symbol shows which type of alarm it is. Snowflake for frost protection, sun for high temperature limit switch, a fan for fan indicator and the input symbol for sensor error.

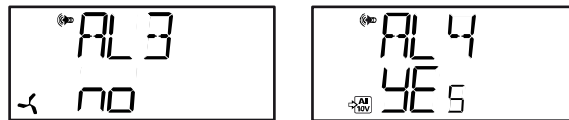

If there are multiple alarms, twist the knob to scroll through them. To acknowledge an alarm, click the knob to enter change mode. Then twist it to change No to Yes and click to acknowledge.

An alarm will remain on the alarm list until it is both acknowledged and has reset. The alarm indicator in the Base Display will remain lit until the alarm list is empty. However, it will only continue to flash as long as there are unacknowledged alarms in the list. Thereafter it will remain steadily lit until all alarms have reset. If DO1 is used as alarm output it will remain activated as long as there are unacknowledged alarms in the alarm list. DO1 cannot be used as an alarm output when 3-point control has been selected.

Chapter 9 Clock and scheduler

The menus for setting the clock and the scheduler times lie in the 3-seconds level. This level is accessed from the basic level by clicking and holding the encoder knob for 3 seconds.

Real time clock



This sample display shows that the time is 13:48 on a Friday, the fifth day of the week.

The 0.0 in the top right corner is a menu display counter. Each configuration menu has a unique number combination. All menus connected to the clock and scheduler belong to the group 0.

To set the clock, click the knob and the day-of-the-week number will start flashing. Twist the knob until the correct day is shown, Monday is 1, Tuesday 2 etc, and then click the knob again to acknowledge the choice. Now the hours will flash. Set them in the same way and then finally the minutes. After confirming the minutes the menu will change to show the first of the scheduler menus.

Note

The clock does not have automatic summertime adaption.

Scheduler, general

The scheduler function is only available for control modes 1, 2, 3 and 4.

The easiest way to understand the scheduler function is to compare it to the type of mechanical timer that has a rotating disk where you can pull out knobs that on passing the switch can turn it ON or OFF. There are 4 ON-points and 4 OFF-points. Each point has its own menupage where 0.1, 0.3, 0.5 and 0.7 are ON-points and 0.2, 0.4, 0.6 and 0.8 are OFF-points.

Control modes 1, 2 and 3 have the same type of scheduler where the ON-points will start the unit and the OFF-points will shut it down.

Control mode 4 uses the scheduler for switching to economy mode (ECO) where the temperature is lowered by a settable number of degrees. Here the ON-points will switch ECONOMY period on and the OFF-points will switch back to comfort temperature.

Scheduler, control modes 1, 2 and 3

Menus 0.1 – 0.8

With the 4 pairs of on-off menu you can create 4 different running periods, either for single days or for a group of days. The day of the week number can be set to any value 1 to 9 or -- for unused menus.

Numbers 1 to 7 represent the days of the week Monday to Sunday. Number 8 will apply the set time every day Monday through Friday and number 9 will apply the set time all 7 days of the week.

For example, you wish the unit to run Monday to Friday between 07:30 and 18:00, Saturday 8:00 to 14:00.

Set first on-time to day 8 and 7:30, the first off-time to day 8 and 18:00. Set the second on-time to day 6 and 8:00 and the second off-time to day 6 and 14:00. Set all others to day --.



If you want the unit to run around the clock, set the on-time to 0:00 and the off-time to 0:00.

Menu 0.9, Override

After the eight switching point menus there is a ninth, 0.9. There the present output status of the scheduler is shown and you can manually override the setting.

If, for example, the switch is shown as ON and you change it to OFF it will remain off either until you manually change it to On again or until the next timer ON-point is reached.

Menu OK

After the scheduler menus there is a final menu, OK. A click on the encoder knob will exit the Clock and Scheduler level and return you to the Basic Display.

Scheduler, control mode 4

Menus 0.1 – 0.8

With the 4 pairs of on-off menus you can create 4 different economy periods, either for single days or for a group of days. The day of the week number can be set to any value 1 to 9 or -- for unused menus.

Numbers 1 to 7 represent the days of the week Monday to Sunday. Number 8 will apply the set time every day Monday through Friday and number 9 will apply the set time all 7 days of the week.

In this application you need to remember that ON will switch ECONOMY period (lowered temperature) on and OFF will switch ECONOMY period off.

For example, every weekday morning you want the temperature to start rising at 06:00 and to remain at comfort level until 21:00. On Saturday and Sunday you want high temperature from 07:00 to 23:30.

Set first on-time to day 8 and 21:00, the first off-time to day 8 and 06:00. Set the second on-time to day 6 and 23:30 and the second off-time to day 6 and 07:00. Set the third on-time to day 7 and 23:30 and the third off-time to day 7 and 07:00.





Should you want the comfort period on Friday to run on until 23:30 you can set the fourth on-time to day 5 and 23:30 and the fourth off-time to day 5 and 21:01. The 1 minute dip will not be noticeable.

Menu 0.9, Setback

After the eight switching point menus there is a ninth, 0.9. In this menu you set the number of degrees you wish to lower the room temperature setpoint during the economy periods. If no room sensor is connected the supply water setpoint will be lowered by 3 times the set value.

Menu OK

After the scheduler menus there is a final menu, OK. A click on the encoder knob will exit the Clock and Scheduler level and return you to the Basic Display.





Chapter 10 Configuration

All the configuration menus lie in the 10-seconds level. This level is accessed from the Base Display by clicking and holding the encoder knob for 10 seconds.

There are numerous configuration menus covering all available options and combinations. In some cases, making a certain choice in one menu will mean that you will only see certain other menus. For example, the menu for setting the damper minimum limit is only shown if you have configured AO2 to be a damper control output.

Menus 1.0 – 5.0

In the first set of configuration menus you choose which of the five control modes you wish to run. The displayed symbol and the first digit in the menu-number show which control mode is at hand

-  1 Supply air temperature control
-  2 Outdoor temperature compensated supply air temperature control
-  3 Cascade connected room / extract air temperature control
-  4 Radiator circuit control with outdoor curve
-  5 Domestic hot water control

Menus X.1

Output type (control modes 1, 2, 3 and 4) (where X depends on your choice of alternative above)

For control modes 1,2, 3 and 4 you can, instead of the 0 – 10 V analogue output, choose to use two digital outputs to control a 3-point (increase/decrease) actuator. In this case DO1 will always be increase (open valve) and DO2 decrease (close valve).

In controlmode 5 you can only have 0 – 10 V analogue output.

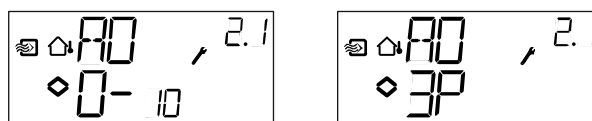

Menu X.A

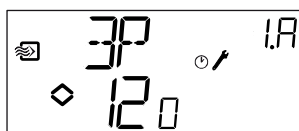

If 3-point control has been configured, a submenu will be shown in which you set the actuator run time. Optigo uses this value to calculate the run time needed to achieve a certain desired output.



Menus X.2 Output signals (control modes 1, 2, 3)

Here you choose the combination of output signals.

If you in the preceding menu have chosen analogue 0...10 V outputs, they can be configured to the following combinations:

AO1	/	AO2	Output symbol	Graphic symbol
1. Heating	/	-	\	☀
2. Cooling	/	-	/	❄
3. Heating	/	Cooling	\/	☀ ❄
4. Heating	/	Heating	\ \	☀ ☀
5. Cooling	/	Cooling	/ /	❄ ❄
6. Heating	/	Damper	\/	☀ 
7. Cooling	/	Damper	\/	❄ 

In alternative 4, Heating-Heating AO2 will be activated first on increasing heat demand.

In alternative 5, Cooling-Cooling AO2 will be activated first on increasing cooling demand.

In alternative 6, Heating-Damper, at temperatures above the setpoint the damper on AO2 will be fully open. On increasing heating demand, the damper on AO2 will first close to the set minimum value before the heating output on AO1 starts to increase.

In alternative 7, Cooling-Damper, at temperatures below the setpoint the damper on AO2 will be fully open. On increasing cooling demand, the damper on AO2 will first close to the set minimum value before the cooling output on AO1 starts to increase.

If you have chosen 3-point output in the preceding menu you will only be able to choose alternatives 1 or 2 with a single output signal.

For each alternative the number representing it is shown along with a graphic symbolisation of the output signal and also a symbol next to the bar-graph for each output.

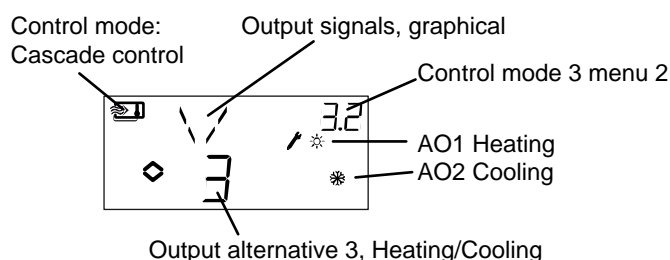

Example, Menu X.2

Room temperature control (Cascade control) with output alternative 3 Heating/Cooling.

Since control modes 4 and 5 are fixed to one step heating in their output function the menus 4.2 and 5.2 are not available.

Menus X.3

Neutral zone (Control modes 1, 2 and 3)

Here you set the neutral zone. This menu is only available for control modes 1, 2 and 3 and only if you have chosen the output signal combination 3, heating – cooling. In this output option you can set a neutral zone between the outputs. The setpoint will be placed at the middle of the neutral zone.

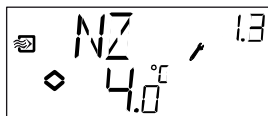

Menu X.4 P-band

Here you set the P-band (Proportional band). The P-band is the control offset necessary to drive an output signal from 0 to 100%. In configurations involving two outputs the same P-band applies to both outputs.

In controlmode 3, Cascade control this setting will set the P-band for the supply air controller. The P-band for the room controller is set by the cascade factor, see menu X.6 below.

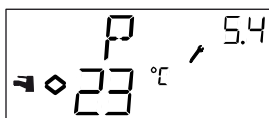

Menu X.5 I-time

Here you set the Integration time (Reset time). Menu X.5 is not shown if 3-point control has been selected in menu X.1.

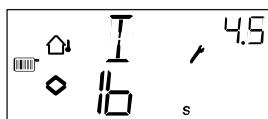

Menu X.6 Damper minimum position (Control modes 1, 2 and 3) P-band room temperature influence (control mode 3) 0°C temperature boost (Control mode 4) D-factor (control mode 5)

Damper minimum position

If you in menu X.2 have configured output AO2 to be a damper, alternative 6 or 7, you can set a minimum value to the damper signal. The damper output will then not go lower than the set value during normal operation. On shut-down however the signal will go to zero and fully close the damper.



P-band room temperature influence

For control mode 3 there is a second 3.6 menu page where you set the room temperature influence P-band PCd. In cascade control an offset in room/extract air temperature will displace the supply air controller's setpoint so as to eliminate the offset. PCd sets the amplification on the corrective signal from the room controller.

Definition of P-band the room temperature influence (PCd): The change in room temperature which results in a change in the supply air setpoint, corresponding to the difference in temperature between the set maximum and minimum limits.

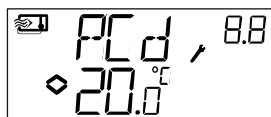

0°C temperature boost

In control mode 4 an extra temperature boost can be added at 0°C outdoor temperature. The boost recedes from the set value to 0 over ± 3 degrees.

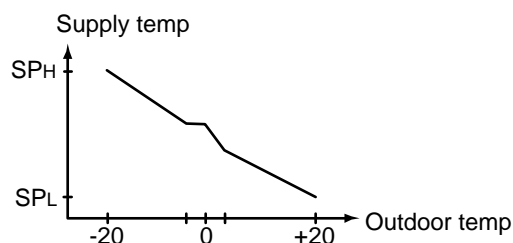

D-factor

Control mode 5, Domestic hot water temperature control is often a very difficult application which calls for responsive control. Optigo therefore utilises PID-control for this control mode. In this menu you set the D-factor (the derivative factor).

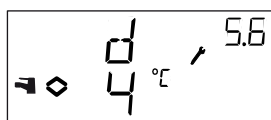

Menus X.7

Universal input UI1 (Control modes 1, 2, 3)

Pump exercise (Control mode 4)

Periodic overheating (Control mode 5)

Input UI1

For control modes 1, 2 and 3 you can choose to configure the universal input UI1 as either an analogue input for a frost protection sensor on either output (snowflake-symbol) in a water-heated system or as a digital input for a high temperature limiting switch (sun-symbol) in an electric heater. It can also be set to --, not active.

If set to frost protection sensor Optigo will activate the frost protection function and also shutdown mode, see chapter 5.

If set to high temperature limit switch, the fan will run for an extra 3 minutes after the heating output has been turned off at shutdown.



Frost protection on AO1



Frost protection on AO2



High temp. limit switch



Not used

Pump exercise

If the pump stands still for prolonged periods during the summer there is the risk of the pump impeller seizing. To reduce this risk the Optigo has a pump exercise function which will start and run the pump for 5 minutes at 15:00 each day. In this menu the exercise function can be turned Off if not desired. Default is On.

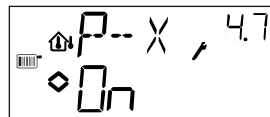

Periodic overheating

To reduce the risk of Legionella bacteria growth a periodic overheating of the water can be configured. The water temperature will be raised to 65°C once daily at 03:00 (3 am). The elevated temperature is maintained for 10 minutes. In this menu the overheating function can be turned Off if not desired. Default is On.

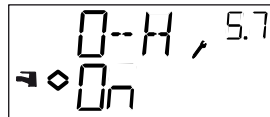

Menu X.8

Startpoint for outdoor compensation, S.P (Control mode 2)

Supply air min limit (Control mode 3)

Low temperature setpoint (Control mode 4)

For control mode 2. S.P is the outdoor temperature at which the setpoint compensation starts. At temperatures lower than S.P a compensation will be added to the setpoint value. The maximum compensation is set in menu 2.9 and is achieved at -20°C



For control mode 3 the supply air temperature can be minimum and maximum limited. In this menu you set the minimum supply air temperature.



For control mode 4 you need to establish a relationship between outdoor temperature and supply water temperature. This is set by the two setpoints SP_L and SP_H where SP_L is the water temperature to be held at an outdoor temperature of $+20^\circ\text{C}$ and SP_H is the water temperature to be held at -20°C . Intermediate values are calculated with linear interpolation. In this menu you set SP_L .



Menus X.9

Maximum compensation, CMP (Control mode 2)

Supply air max limit (Control mode 3)

High temperature setpoint (Control mode 4)

For control mode 2. The maximum setpoint compensation value.

Compensation will start to be added to the setpoint value when the outdoor temperature falls below the start point S.P entered in menu 2.8. The compensation will increase linearly up to the maximum value CMP which is reached when the outdoor temperature has fallen to -20°C



For control mode 3 the supply air temperature can be minimum and maximum limited. In this menu you set the maximum supply air temperature.

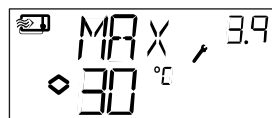

For control mode 4 you need to establish a relationship between outdoor temperature and supply water temperature. This is set by the two setpoints SP_L and SP_H where SP_L is the water temperature to be held at an outdoor temperature of $+20^\circ\text{C}$ and SP_H is the water temperature to be held at -20°C . Intermediate values are calculated with linear interpolation. In this menu you set SP_H .

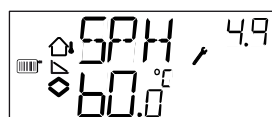

Menu X.E

In this menu, you set whether you want to use an external setpoint device or set the setpoint via the display. External setpoint can be used for control modes 1-3 and control mode 4 when using a room sensor. This menu is only available for controllers with revision number R20 or later.



Menu I/O

After the last configuration menus there is a menu where you can look at the actual values of all the inputs and outputs.

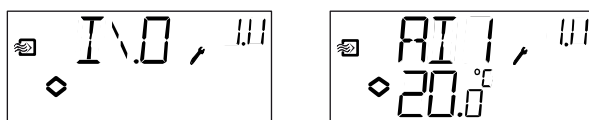

Menu OK

Last of the configuration level menus is the OK-menu. To leave the configuration level, go to this menu and click on the encoder knob.



On exit from the configuration level you will not be returned to the Basic level but to the Time and Scheduler level.

There is also a time-out function that will automatically exit the configuration level after 5 minutes of inaction.

Storage of settings

All configuration settings become valid as soon as they are entered by clicking the encoder knob. They are however not written to the flash memory until you exit the configuration level either via the OK menu or via the time-out function.

To exit the configuration level without saving the changes to flash memory, cut the supply voltage when still in the configuration level. All values will be kept as they were before you entered the configuration level.

Reset to factory setting

The OP10 can be reset to factory settings by configuring Domestic hot water control (mode 5) and setting the D-factor to 99. Go to the Basic Display. Then cut the power supply. When power is reapplied all configuration and scheduler settings will be reset to factory setting.

Chapter 11 Index

1

10-second level 23, 30

3

3-second level 23, 27

A

Analogue inputs 12
Analogue outputs 12

B

Basic level 22

C

Clock 27
Configuration 30
Configuration level 23
Control modes 7
 Domestic hot water control 21
 Radiator circuit control 19
 Temperature control 14

D

Damper 17
Digital inputs 12
Display and encoder 22
Domestic hot water overheating 34

E

EMC 8
Extended running 18

F

Factory settings, reset to 36
Fan indication 17

I

Inputs and outputs 7, 12
 Analogue inputs 12
 Analogue outputs 12
 Digital inputs 12
 Universal inputs 12
Installation 10

L

LVD 8

M

Menu
 Configuration 30
 I/O 22, 36
 OK 28, 29, 36
 Setback 29
 Setpoint 23, 25
 X.E 35
Mounting 6

O

Outdoor compensation 17
Overheating 34
Override 28

P

Pump exercise 34

S

Scheduler 27

Scheduler override.....	28
Setback	29
Setpoint	25
Shutdown mode.....	17

T

Technical data	8
Inputs.....	8
Outputs	9

U

Universal inputs.....	12
-----------------------	----

V,W

Wiring.....	11
Wiring diagram	
Control mode 4.....	20
Control mode 5.....	21
general	11



AB Regin

Head office

Box 116, S-428 22 Källered,
Sweden

Phone: +46 31 720 02 00
Fax: +46 31 720 02 50

info@regin.se
www.regin.se

Germany

RICCIUS + SOHN GmbH

Haynauer Str. 49
D-12249 Berlin

Phone: +49 30 77 99 40
info@riccius-sohn.eu
www.riccius-sohn.eu

France

Regin Controls SARL

32 rue Delizy
F-93500 Pantin

Phone: +33 1 41 71 00 34
info@regin.fr
www.regin.fr

Spain

Regin Ibérica, S.A.

C/Arganda 18 local
E-28005 Madrid

Phone: +34 91 473 27 65
info@regin.es
www.reginiberica.com

Singapore

Regin Controls
Asia Pacific Pte Ltd

66 Tannery Lane
03-04 Sindo Building
Singapore 347805

Phone: +65 6747 8233
info@regin.com.sg
www.regin.com.sg

Hong Kong

Regin Controls
Hong Kong Ltd

Room 2901
EW International Tower
120 Texaco Road
Tsuen Wan, NT
Hong Kong

Phone: +852 2407 0281
info@regin.com.hk
www.regin.com.hk